

Linear

MOMO-R RGB Fixture Guide

KKDÖ

Indoor/Outdoor | Recessed | RGB output

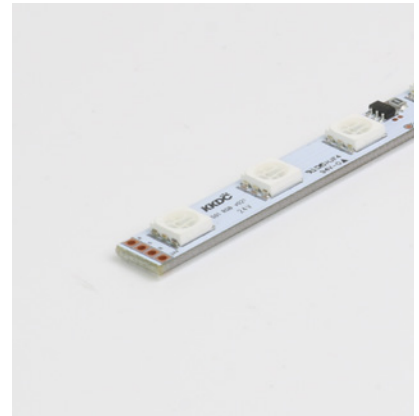
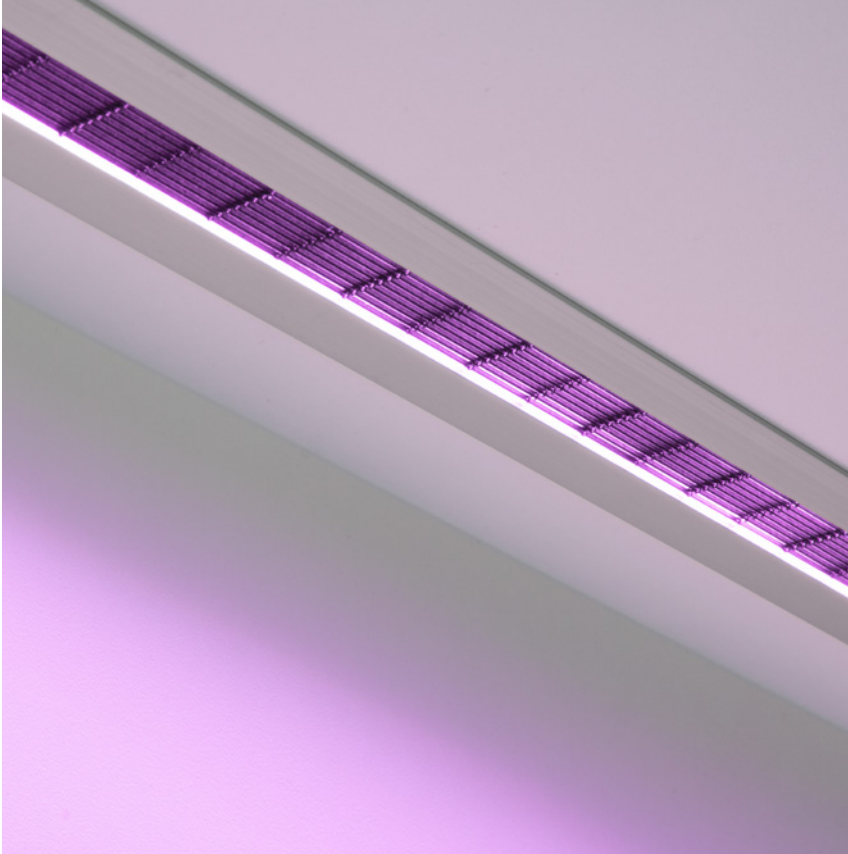

Key applications

- ✓ Bathrooms
- ✓ Ceiling
- ✓ Direct lighting
- ✓ Downlighting
- ✓ Exterior
- ✓ Interior
- ✓ Special effect
- ✓ Wall grazing
- ✓ Wallwashing
- ✓ Wet area

Key features

- ✓ Custom lengths
- ✓ Constant Voltage (CV)
- ✓ Diffusion: homogenous
- ✓ Direct view
- ✓ Glare control options
- ✓ IP44 moisture resistant
- ✓ IP67 waterproof
- ✓ Lens options
- ✓ RGB

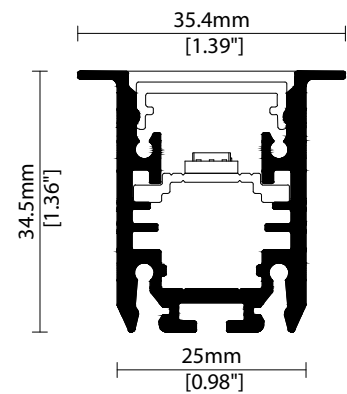

MOUNTING METHODS



KKSB-01 Spring bracket

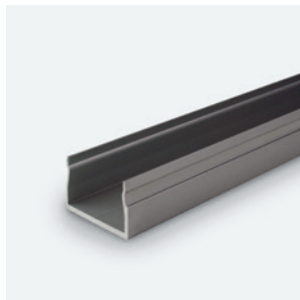

KKCR-01-1000 Cable raceway (1000mm)
KKCR-01-2000 Cable raceway (2000mm)
KKCR-01-3000 Cable raceway (3000mm)

Linear

MOMO-R RGB

Specification sheet



Dimensions	H34.5/W35.4/L108-2025mm (H1.36/W1.39/L4.25-79.72in)
PCB Cut-point	83.3mm increment/2000mm max (3.28in increment/78.74in max)
LED Pitch	13.9mm-72LED/m (0.55in - 22LED/ft)
Chip	RGB
Cover/Optics	Clear (100°)/Clear + Micro louvre/KKLN-01 lens (18°)/Clear + KKLN-01 lens (18°) + Micro louvre/Clear + KKLN-03 lens (23°)/Clear + KKLN-03 lens (23°) + Micro louvre/Diffused (95°)
CCT	Red 620-625nm/Blue 455-460nm/Green 520-525nm
LED binning	5nm tolerance
CRI	N/A
Lifetime	50,000 hours @ 25°C (50,000 hours @ 77°F)
Operating temp	T _a = -20 to 60°C (T _c max = 70°C) T _a = -4 to 140°F (T _c max = 158°F)
IP Rating	IP44/67
Finish	Silver anodised
Mounting	Recessed mounting via spring clip/Cable race way
Power feed	Sheathed hardwire tails or male/female connectors
Control	DMX/DALI



Power consumption	Supply voltage	Supply current
15.6W/m (4.75W/ft)	24V DC	0.65A/m (0.20A/ft)

Clear	Clear + Micro Louvre	Clear + KKLN-01 (18°)	Clear + KKLN-01 (18°) + Micro Louvre	Clear + KKLN-03 (23°)	Clear + KKLN-03 (23°) + Micro Louvre	Diffused Cover
Red: 125lm/m (38lm/ft)	Red: 37lm/m (11lm/ft)	Red: 69lm/m (21lm/ft)	Red: 34lm/m (10lm/ft)	Red: 70lm/m (21lm/ft)	Red: 39lm/m (12lm/ft)	Red: 56lm/m (17lm/ft)
Green: 266lm/m (81lm/ft)	Green: 77lm/m (24lm/ft)	Green: 147lm/m (45lm/ft)	Green: 73lm/m (22lm/ft)	Green: 149lm/m (45lm/ft)	Green: 84lm/m (26lm/ft)	Green: 119lm/m (36lm/ft)
Blue: 42lm/m (13lm/ft)	Blue: 12lm/m (4lm/ft)	Blue: 23lm/m (7lm/ft)	Blue: 11lm/m (3lm/ft)	Blue: 23lm/m (7lm/ft)	Blue: 13lm/m (4lm/ft)	Blue: 19lm/m (6lm/ft)
RGB: 383lm/m (117lm/ft)	RGB: 111lm/m (34lm/ft)	RGB: 212lm/m (65lm/ft)	RGB: 105lm/m (32lm/ft)	RGB: 214lm/m (65lm/ft)	RGB: 120lm/m (37lm/ft)	RGB: 171lm/m (52lm/ft)

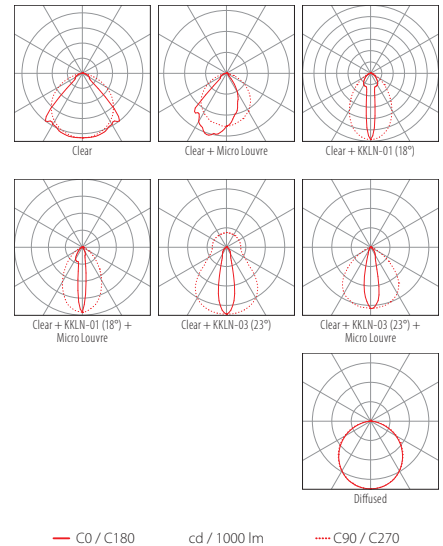
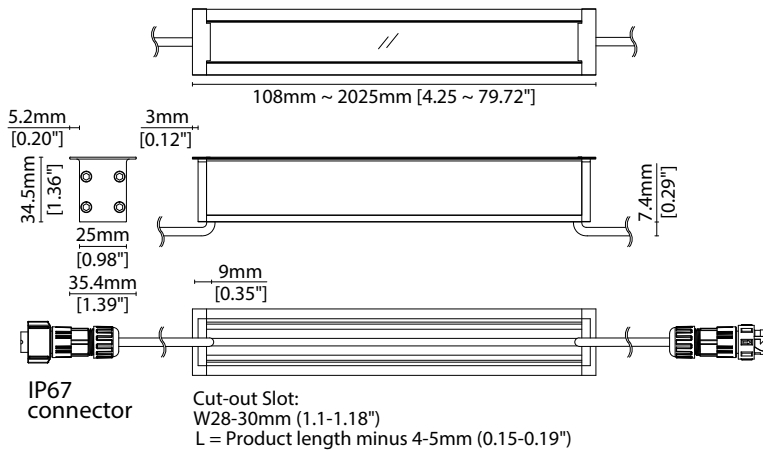

Data derived from production samples tested to UKAS/IESNA LM-79-08 standards.

FIXTURE

Model	Finish	Cover/Lens ¹	Grade	LED	Colour (CCT)	Length Availability ²	IP	Cable Length	Power Feed ³	Input	
MOMO-R	OR	Silver Anodised	SA	Clear	B	m 108-2025mm 83.3mm increments i 4.26-79.72in 3.28in increments (Specify length code OR total run length)	IP44 44	300mm/ 11.81"	Single ø4.3mm sheath tail	S00A	DC 24V g
				Clear + Micro Louvre	K		IP67 ⁴ 67				
				Clear + KKLN-01 (18°)	P						
				Clear + KKLN-01 (18°) + Micro Louvre	U						
				Clear + KKLN-03 (23°)	A						
				Clear + KKLN-03 (23°) + Micro Louvre	AK						
				Clear + Diffused	C						
								Double ø4.3mm sheath tail	D00A		
								Single ø4.3mm sheath IP67 connector	S67A		
								Double ø4.3mm sheath IP67 connector	D67A		

¹ Refer to **Cover/Lens Options** on **Options** pages ² Refer to **Length Availability List** or enter total run length instead of length code ³ Refer to **Power Feed Options** on **Options** pages

⁴ Due to the clear, flush potted polyurethane top layer on IP67 MOMO-R a colour shift of +/-20K should be expected

Code Example:

OR	-	SA	-	C	-	s	-	501	-	RGB	-	m	525	-	67	-	0300	-	D67A	-	g
MOMO-R		Silver Anodised		Diffused				501		RGB			524.8mm		IP67		300mm/11.81"		Double ø4.3mm sheath IP67 connector		DC 24V

ACCESSORIES

Mounting Accessories

KKSB-01	Spring bracket
KKCR-01-1000	1000mm/39.37" Cable Raceway
KKCR-01-2000	2000mm/78.74" Cable Raceway
KKCR-01-3000	3000mm/118.11" Cable Raceway

* Refer to **Mounting accessories** on **Accessories** pages

Connection Accessories

CN67-4P-0300	IP67 4 PIN LEDmix male & female 300mm/11.81" pair
CN67-4P-1000	IP67 4 PIN LEDmix male & female 1000mm/39.37" pair
CN67-4P-3000	IP67 4 PIN LEDmix male & female 3000mm/118.11" pair

* Refer to **Power feed** on **Accessories** pages

Exterior Junction Boxes

KKJB-07	IP67 Slim J-Box
KKJB-07R	Potting Resin for IP67 Slim J-Box

* Refer to **Exterior Junction Boxes** on **Accessories** pages

PSU/Driver

0-10V/1-10V/DALI/DMX

* Refer to **Driver/PSU Options** page for details or provide requirement and KKDC to offer the suitable option

LED ENGINE VARIANTS (LED STRIP TYPE)

Colour	LED	Lumen/m	Lumen/ft	W/m	W/ft	Spec Doc	Length	Increment
Single CCT	R007	563	172	7	2.13	MOMO-R R007	108-2025mm (4.25-79.72in)	41.7mm (1.64in)
	R014	1152	351	14	4.27	MOMO-R R014	108-2025mm (4.25-79.72in)	41.7mm (1.64in)
	R020	1632	498	20	6.10	MOMO-R R020	108-2025mm (4.25-79.72in)	41.7mm (1.64in)
	R030	2309	704	30	9.14	MOMO-R R030	108-2025mm (4.25-79.72in)	41.7mm (1.64in)
	A040	3668	1118	40	12.19	MOMO-R A040	102-1525mm (4.01-60.03in)	38.46mm (1.51in)
	Warm Dim/Dynamic White	R207	1282	391	16	4.88	MOMO-R R207	108-2025mm (4.25-79.72in)
RGB	501	Red 125 Green 266 Blue 42 RGB 383	Red 38 Green 81 Blue 13 RGB 117	15.6	4.75	MOMO-R RGB	108-2025mm (4.25-79.72in)	83.3mm (3.28in)
RGBW	R201	973	297	20	6.1	MOMO-R RGBW	160-2035mm (6.30-80.12in)	62.5mm (2.46in)

* Performance data: clear cover, RGB

MOMO-R RGB

Length Availability List



Length Code		Fixture Length ¹		LED Strip ²		End Cap Dimension ³		Wattage (W)	Output (lm)			
Metric	Imperial(US)	Metric	Imperial(US)	Metric	Imperial(US)	Metric	Imperial(US)		R	G	B	W
m0103	i0004	108mm	4.27in	83mm	3.28in	15mm	0.59in	1.30	10	22	4	32
m0187	i0008	192mm	7.55in	167mm	6.56in	15mm	0.59in	2.60	21	44	7	64
m0270	i0011	275mm	10.83in	250mm	9.84in	15mm	0.59in	3.90	31	66	11	96
m0353	i0014	358mm	14.11in	333mm	13.12in	15mm	0.59in	5.20	42	89	14	128
m0437	i0017	442mm	17.39in	417mm	16.40in	15mm	0.59in	6.50	52	111	18	160
m0520	i0021	525mm	20.67in	500mm	19.69in	15mm	0.59in	7.80	62	133	21	191
m0603	i0024	608mm	23.95in	583mm	22.97in	15mm	0.59in	9.10	73	155	25	223
m0687	i0027	692mm	27.23in	667mm	26.25in	15mm	0.59in	10.40	83	177	28	255
m0770	i0031	775mm	30.51in	750mm	29.53in	15mm	0.59in	11.70	94	199	32	287
m0853	i0034	858mm	33.80in	833mm	32.81in	15mm	0.59in	13.00	104	222	35	319
m0937	i0037	942mm	37.08in	917mm	36.09in	15mm	0.59in	14.30	114	244	39	351
m1020	i0040	1025mm	40.36in	1000mm	39.37in	15mm	0.59in	15.60	125	266	42	383
m1103	i0044	1108mm	43.64in	1083mm	42.65in	15mm	0.59in	16.90	135	288	46	415
m1187	i0047	1192mm	46.92in	1167mm	45.93in	15mm	0.59in	18.20	146	310	49	447
m1270	i0050	1275mm	50.20in	1250mm	49.21in	15mm	0.59in	19.50	156	332	53	479
m1353	i0053	1358mm	53.48in	1333mm	52.49in	15mm	0.59in	20.80	166	355	56	511
m1437	i0057	1442mm	56.76in	1417mm	55.77in	15mm	0.59in	22.10	177	377	60	543
m1520	i0060	1525mm	60.04in	1500mm	59.06in	15mm	0.59in	23.40	187	399	63	574
m1603	i0063	1608mm	63.33in	1583mm	62.34in	15mm	0.59in	24.70	198	421	67	606
m1687	i0067	1692mm	66.61in	1667mm	65.62in	15mm	0.59in	26.00	208	443	70	638
m1770	i0070	1775mm	69.89in	1750mm	68.90in	15mm	0.59in	27.30	218	465	74	670
m1853	i0073	1858mm	73.17in	1833mm	72.18in	15mm	0.59in	28.60	229	488	77	702
m1937	i0076	1942mm	76.45in	1917mm	75.46in	15mm	0.59in	29.90	239	510	81	734
m2020	i0080	2025mm	79.73in	2000mm	78.74in	15mm	0.59in	31.20	250	532	84	766

¹ Actual total overall length of light fixture (LED strip + end caps + void/wire hole)

² Actual length of PCB strip

³ Actual length of 2x end caps

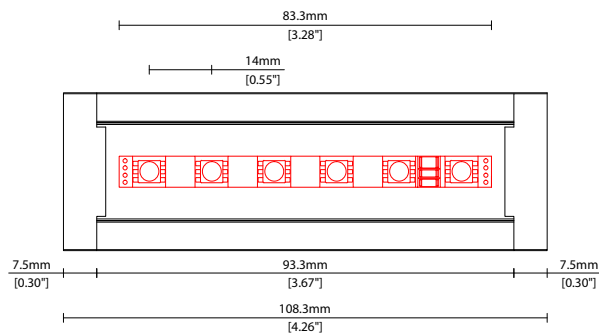

CUT-OUT SLOT:
W28-30mm (1.1-1.18")
L = Product length minus 4-5mm (0.15-0.19")

COVER/LENS OPTIONS

* Options are an integral part of the fixture ordering codes. Please refer to **Code Table** pages.

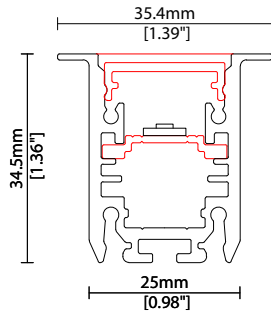
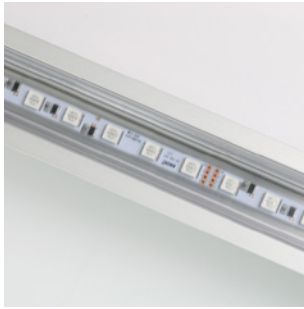

B Clear Cover
W25.0/H34.5mm (W0.98/H1.36")

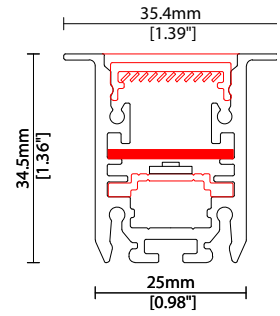
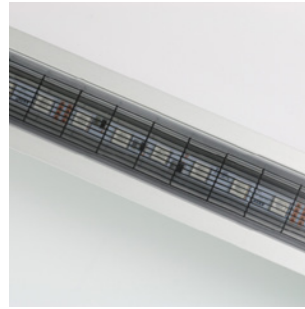

K Clear Cover + Micro Louvre
W25.0/H34.5mm (W0.98/H1.36")

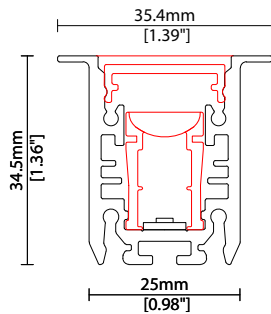
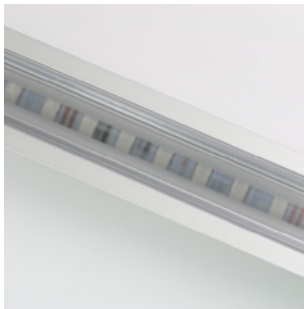

P Clear + KKLN-01 (18°)
W25.0/H34.5mm (W0.98/H1.36")

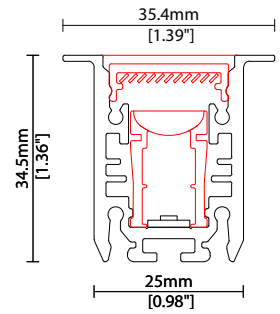
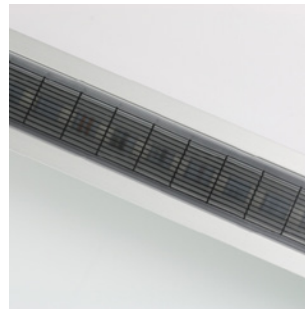

U Clear + KKLN-01 (18°)
+ Micro Louvre
W25.0/H34.5mm (W0.98/H1.36")

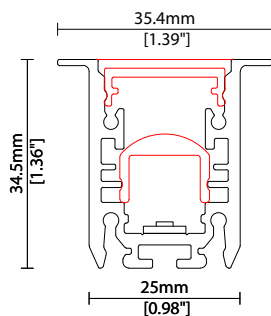

A Clear + KKLN-03 (23°)
W25.0/H34.5mm (W0.98/H1.36")

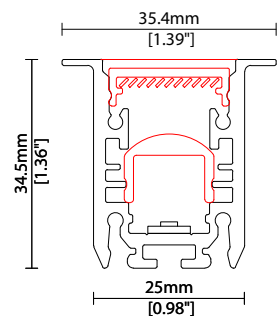

AK Clear + KKLN-03 (23°)
+ Micro Louvre
W25.0/H34.5mm (W0.98/H1.36")

Linear

MOMO-R RGB Options

KKDC

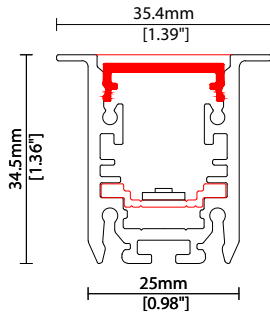

C Diffused

W25.0/H34.5mm (W0.98/H1.36")

POWER FEED OPTIONS

0300 S00A 300mm (11.81") Single Ø4.3mm sheath tail

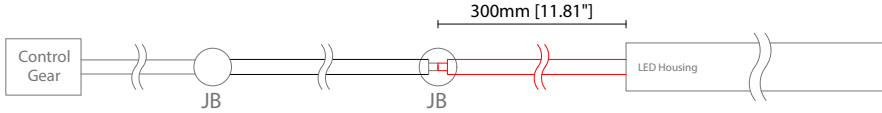

0300 D00A 300mm (11.81") Double Ø4.3mm sheath tail

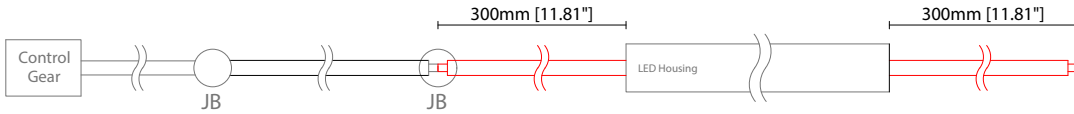

0300 S67A 300mm (11.81") Single ø4.3mm sheath IP67 connector

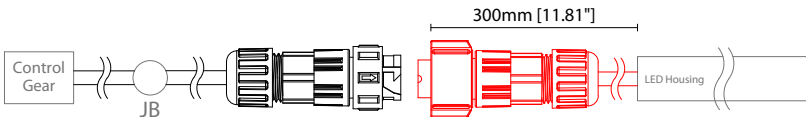

0300 D67A 300mm (11.81") Double ø4.3mm sheath IP67 connector

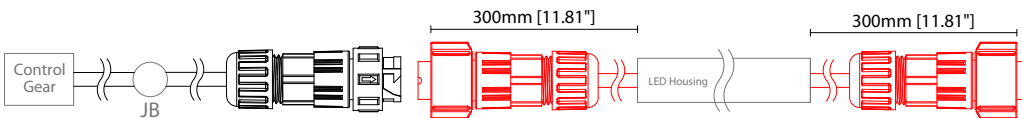

4 Pin RGB Female Connector

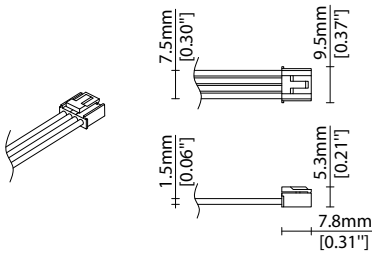

4 Pin RGB Male Connector

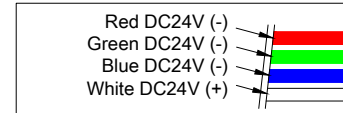
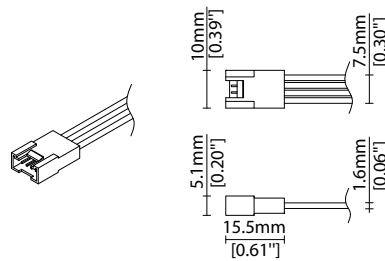

IP67 4 Pin Connector

Female connector
4 PIN (IP67)

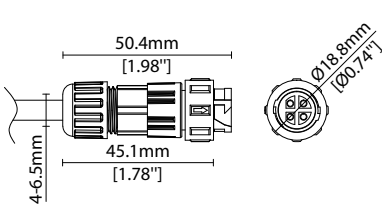

Male connector
4 PIN (IP67)

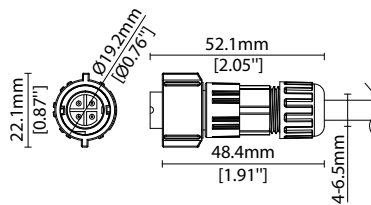

Key

Control Gear Power supply, sub-controllers & control systems

JB Junction box / cable connection

MOUNTING ACCESSORIES

Note: Accessories are to be ordered separately with corresponding code shown below.



KKSB-01

Spring bracket
(allow 2 per metre/40")
Anodised aluminium finish
L31/W35.4/H45.2mm
(L1.22/W1.39/H1.78")

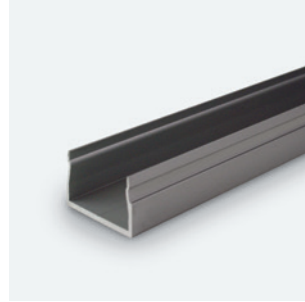
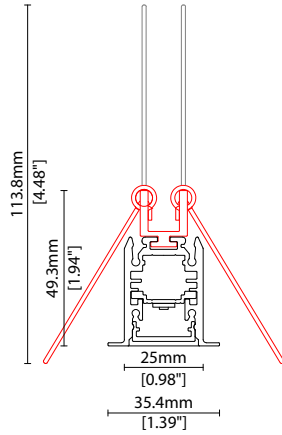

KKCR-01-1000 1000mm (39.37in)
KKCR-01-2000 2000mm (78.74in)
KKCR-01-3000 3000mm (118.11in)

Cable raceway*
anodised aluminium finish
W22/H36.4mm (W0.87/H1.43")
* Cut & drilled to fit on site

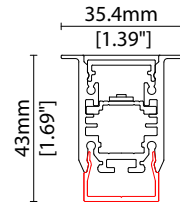

POWER FEED

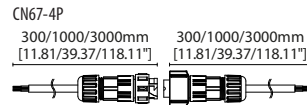

CN67-4P-0300 300mm (11.81in) pair
CN67-4P-1000 1000mm (39.37in) pair
CN67-4P-3000 3000mm (118.11in) pair

IP67
4 PIN male + female (RGB/LEDmix) connector set

EXTERIOR JUNCTION BOXES



KKJB-07

IP67 Slim J-Box
(including type A,B,C,D bushings)



KKJB-07R

Potting resin for IP67 Slim J-Box

KKDC CONTROL



KKDM-06 1-10V

visDIM dimmable sub-controller
(4 x 8A max @ 12-36V)

IP20
Plastic housing
L170/W59/H29mm
(L6.69/W2.32/H1.14in)



KKSC-05 DMX

visDIM dimmable sub-controller
(4 x 5A max @ 12-36V)

IP20
Plastic housing
L170/W53.4/H28mm
(L6.69/W2.10/H1.10in)



KKDL-02 DALI

visDIM dimmable sub-controller
(4 x 8A max @ 12-36V)

IP20
Plastic housing
L170/W59/H29mm
(L6.69/W2.32/H1.14in)



KKDL-03 DALI

visDIM dimmable sub-controller
(4 x 5A max @ 12-36V)

IP20
Plastic housing
L166/W53.4/H23mm
(L6.54/W2.10/H0.91in)

AVAILABLE PSU OPTIONS

Control Mode	PSU (Order Code)	Input Voltage AC	Output Voltage DC	Rated Output Current	Rated Power	Dim %	IP Rating
Switched	CEN-60-24	90-295V	24V	2.5A	60W	-	IP67
	HLG-60H-24	90-305V	24V	2.5A	60W	-	IP67
	HLG-100H-24	90-305V	24V	4.0A	100W	-	IP67
	HLG-150H-24	90-305V	24V	6.3A	150W	-	IP67
	HLG-240H-24	90-305V	24V	10A	240W	-	IP67
0-10V (1-10V)	PWM-40-24	90-305V	24V	1.67A	40W	100-0.15 (100-10)	IP67
	PWM-60-24	90-305V	24V	2.5A	60W	100-0.15 (100-10)	IP67
	PWM-90-24	90-305V	24V	3.67A	90W	100-0.15 (100-10)	IP67
	PWM-120-24	90-305V	24V	5.0A	120W	100-0.15 (100-10)	IP67
DALI	LIN100A1	120-277V	24V	1A per channel	100W	100-0.1	IP66/IP40
DMX RGB	LIN100A1	120-277V	24V	1.33A per channel	100W	100-0.1	IP66/IP40
DMX RGBW	LIN100A1	120-277A	24V	1A per channel	100W	100-0.1	IP66/IP40

Flicker Free Options - Combination of PSU+ sub-controller

Control Mode	PSU (Order Code)	Sub-controller (Order Code)	Input Voltage AC	Output Voltage DC	Rated Output Current	Rated Power	Dim %	IP Rating PSU/ Sub-controller
0-10V or 1-10V	CEN-60-24	KKDM-06	90-295V	24V	2.5A	60W	100-0.9	IP67/IP20
	HLG-60H-24	KKDM-06	90-295V	24V	2.5A	60W	100-0.9	IP67/IP20
	HLG-100H-24	KKDM-06	90-295V	24V	4.0A	100W	100-0.9	IP67/IP20
	HLG-150H-24	KKDM-06	90-295V	24V	6.3A	150W	100-0.9	IP67/IP20
	HLG-240H-24	KKDM-06	90-295V	24V	10.0A	240W	100-0.9	IP67/IP20
DALI	CEN-60-24	KKDL-02/03	90-295V	24V	2.5A	60W	100-0.1	IP67/IP20
	HLG-60H-24	KKDL-02/03	90-305V	24V	2.5A	60W	100-0.1	IP67/IP20
	HLG-100H-24	KKDL-02/03	90-305V	24V	4.0A	100W	100-0.1	IP67/IP20
	HLG-150H-24	KKDL-02/03	90-305V	24V	6.3A	150W	100-0.1	IP67/IP20
	HLG-240H-24	KKDL-02/03	90-305V	24V	10.0A	240W	100-0.1	IP67/IP20
DMX RGB	CEN-60-24	KKSC-05	90-295V	24V	2.5A	60W	100-0.9	IP67/IP20
	HLG-60H-24	KKSC-05	90-305V	24V	2.5A	60W	100-0.9	IP67/IP20
	HLG-100H-24	KKSC-05	90-305V	24V	4A	100W	100-0.9	IP67/IP20
	HLG-150H-24	KKSC-05	90-305V	24V	6.3A	150W	100-0.9	IP67/IP20
	HLG-240H-24	KKSC-05	90-305V	24V	10.0A	240W	100-0.9	IP67/IP20

¹ The items shown above cover the most frequently used specification but does not exhaust the possible options

² PSU and/or driver can be chosen from the table, or KKDC may recommend the best option upon receipt of the controls requirement and installation environment

³ Electrical shop drawing will include detailed information of PSU and relevant control drivers

⁴ Cut sheets are available on the controls section of www.kkdc.lighting or upon request